

Made in Germany

**FOLD OUT ...**

to have everything at a glance.

**FOLD IN ...**

to know what comes next.

**PICTOGRAMS**

 ø 8.2 mm Long cone

 ø 8.2 mm Short cone

 ø 10.2 mm Short cone

 ø 11.2 mm Short cone

 ø 17 mm Short cone

 ø 12.5 mm  
Sharpens wax crayons

 Removes only the wood

 Sharpens the  
exposed lead

 ø 2 mm  
Sharpens refills for  
retractable pencil leads

 Inking edge

 Bevelled edge

 Removable grip

 for Lefties

 Safety closure  
keeps shavings inside

**Short cone:** broad sharpening angle,  
ideal for coloured pencils and pencils  
with soft leads

**Long cone:** narrow, tapered sharpening  
angle, ideal for lead pencils with hard leads

Made in Germany



13

PRODUCT CATALOGUE



**Möbius+Ruppert KG**  
Wöhrmühle 2  
91056 Erlangen/Germany  
tel +49 (0) 91 31 82 69-0  
fax +49 (0) 91 31 82 69-26  
www.moebius-ruppert.com  
office@moebius-ruppert.com



## BRANDED QUALITY MADE IN GERMANY

Sharpening, drawing, cutting – for perfect results every time you can rely on us: Möbius+Ruppert. As a family-owned producer of branded goods now in the fourth generation, we have been creating innovative, design-orientated products the market wants since 1922. Whether it's a manual sharpener, reduction scale or a paper trimmer, as simple as these products may seem, our special strength lies in reinventing them constantly for our customers for more than 90 years.

Every year we dream up practical designs, use innovative materials and optimize our processes – constantly searching for new features which will make these familiar activities surprisingly simpler, easier and more ergonomic for the user.

In addition to our products, our personal discussions with customers and business partners also show that we put every last ounce of effort into our work. Sharpen your senses: This is a process that calls for concentration, sensitivity and curiosity. You can experience it all in this catalogue. Join us on a journey through our world of products and discover sharpeners, drawing instruments and cutting machines for every age and need.

**Let us inspire you!**



### A SOLID TRADITION OF QUALITY

For us, the manufacture of quality products has always represented both a commitment and a goal. At Möbius+Ruppert, "Made in Germany" really means conceived, designed, and produced in Germany. That is the only way we can assure the quality of our many sharpeners and drawing instruments down to the smallest details, and make sure that we reliably deliver to the highest standards for our customers.

Möbius+Ruppert were awarded the TOP 100 quality seal in 2002 for the development of a particularly innovative sharpener.



- Company-produced blades with an extremely long service life, corrosion protection, high HRC surface hardness and ideal pencil guidance
- Innovative use of a variety of materials: plastic, metal, wood, organic materials
- All drawing instruments have accurate, long-lasting embossed markings
- All products are free of contaminants and plasticizers
- All colours and materials are suitable for contact with foodstuffs
- All products are available with customized designs on request



### CONTENTS

<b>Kindergarten &amp; Preschool</b> .....	4 - 7
<b>School &amp; Hobby</b> .....	8 - 17
Sharpeners .....	8 - 13
Drawing instruments .....	14 - 17
<b>Office &amp; Studio</b> .....	18 - 29
Sharpeners .....	18 - 21
Drawing instruments .....	22 - 27
Cutting machines .....	28 - 29
<b>Green Office</b> .....	30 - 33
<b>Point of Sale</b> .....	34
<b>Register</b> .....	35

Made in Germany

**FOLD OUT ...**  
to have everything at a glance.

**FOLD IN ...**  
to know what comes next.

### PICTOGRAMS

- ø 8.2 mm Long cone
- ø 8.2 mm Short cone
- ø 10.2 mm Short cone
- ø 11.2 mm Short cone
- ø 17 mm Short cone
- ø 12.5 mm Sharpens wax crayons
- Removes only the wood
- Sharpens the exposed lead
- ø 2 mm Sharpens refills for retractable pencil leads
- Inking edge
- Bevelled edge
- Removable grip
- for Lefties
- Safety closure keeps shavings inside

**Short cone:** broad sharpening angle, ideal for coloured pencils and pencils with soft leads  
**Long cone:** narrow, tapered sharpening angle, ideal for lead pencils with hard leads

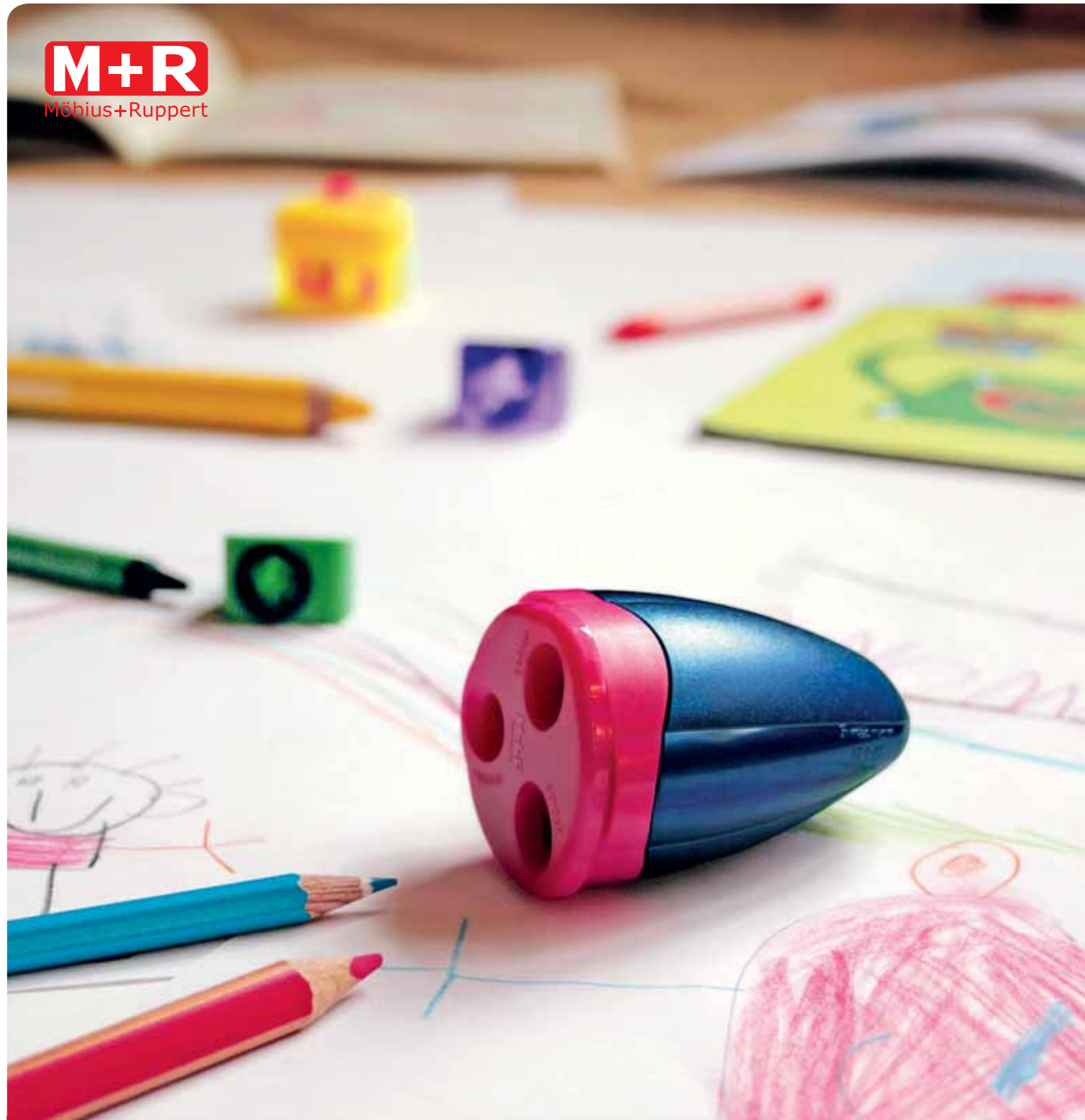

## Kindergarten & Preschool

**Easy and playful sharpening** – specially designed for little hands who are just getting started colouring and writing, and for their creative parents. We've put together an extensive assortment, with sharpeners for wax crayons, thin and super-thick coloured pencils, and for travelling.

## ERGONOMIC AND PRACTICAL

Möbius+Ruppert offers sharpeners and combination sharpeners specially designed for sharpening different diameter coloured pencils, easily yet precisely.



### THREE IN ONE

The sharpener for pencils in three different diameters for sharpening all normal lead, coloured and jumbo pencils.



0969

SPACESHIP



- ▶ Three hole container sharpener for lead, coloured and jumbo pencils, twist closure with extra marking for lead and coloured pencils, with integrated plastic three hole sharpener, ergonomic shape, stand-up function when shavings lid is closed



# JUST FOR KIDS

Just like crayons and pencils, sharpeners for preschoolers and kids in kindergarten must meet special requirements. Möbius+Ruppert does this with sharpeners that are just right for children.



## CLEANLY SHARPEN WAX CRAYONS

Their soft texture and intense colours make wax crayons ideal for small children. However, they lose their point quickly and then give only a broad stroke until an adult resharpens them. Now young artists can sharpen their crayons themselves. This sharpener is designed especially for wax crayons, and makes resharpening child's play. It includes an adapter to fit the opening to the thickness of the wax crayon.



0342  
WAXI



- Sharpener for wax crayons, single hole, with integrated point shaper and adapter for different diameters



0958  
TRIO SWING®



- Container sharpener for lead and coloured pencils, double hole, with integrated metal sharpener

0957  
TRIO SWING®



- TRIO SWING® is also available as a single hole with **large diameter** sharpener



0959  
TOP TRIO SWING®



- Container sharpener for pencils and crayons, three hole, with integrated plastic sharpener, twist closure



Möbius + Ruppert received the ISPA & Innovation Award in 2006 for three hole sharpener TOP TRIO SWING®



0332



- Sharpener for lead and coloured pencils, double hole, block design



0333



- Container pencil sharpener, single hole, integrated plastic sharpener with injection-moulded blade, closable

## CUTTING MACHINE FOR CREATIVE ACTIVITIES

With a 52 cm cutting length, this rotary trimmer is specially designed for larger items like construction paper. It can also make perforations and a wave cut.



6752  
RollCat Premium Line

- Details on page 29.

## FOR EXTRA THICK COLOURED PENCILS

We developed this hand sharpener for XXS artists with XXL coloured pencils. It features a protective cover over the blade. A specially designed cone sharpens the lead to a stable, compact point.



0316  
MAXI



- Sharpener for coloured pencils, wedge design, for extra fat pencils



## School & Hobby

**Have fun getting it done** – that's what matters for school and hobbies. And that's exactly what we encourage, with clever products, a wide variety of materials and surprising designs. Take your inspiration from us and invite your customers to enter a world of colours, shapes and possibilities they never dreamed of.

## ERGONOMIC AND SAFE

Innovative spirit and creativity have always been the driving force behind our success. For young creatives we've developed the ERGO SWING®, an ergonomically designed container sharpener that fits perfectly in little hands. To keep shavings and dust on the inside, the sharpening hole has a folding closure. The cover is held shut by a pressure-point lock. The NEO LIGHT for teenagers is also closable with a flip top, and enters the scene in fashion colours and a semi-transparent design.

0948

ERGO SWING®



► Ergonomic container sharpener with folding closure, for lead and coloured pencils, with integrated metal sharpener



With its ergonomic shape, the ERGO SWING® snuggles right into a child's hand. The extra-safe pressure-point cover lock keeps it shut in the school bag. The sharpening hole has a folding closure for the same purpose, which automatically moves down when a pencil is

pushed into the hole. An integrated metal sharpener and two hole sizes ensure the high sharpening quality you expect.

0902

NEO LIGHT



► Container sharpener with flip top for lead and coloured pencils, with integrated metal sharpener



Top of trend, in a selection of today's colour combinations – NEO LIGHT combines form and function. Full-featured, with transparent flip top, integrated metal sharpener and two hole sizes.



# CLASSICS AND SPECIAL MODELS

The Möbius+Ruppert line of sharpeners for school & hobby starts with proven classics like magnesium sharpeners in single and two-hole versions without housing, continues with sharpeners that fit nicely in a pencil case, and wraps it all up with handy, colourful container sharpeners.



**0200 0700**  

- ▶ Pencil sharpener, single hole, block design, with 2 replacement blades, in case



**0201**  

- ▶ Pencil sharpener, single hole, wedge design



**0211**  

- ▶ Sharpener for lead and coloured pencils, double hole, wedge design



**0211 0700**  

- ▶ Sharpener for lead and coloured pencils, double hole, wedge design, with two replacement blades, in case



**0304**  

- ▶ Pencil sharpener, single hole, block design



**0305**  

- ▶ Pencil sharpener, single hole, block design



**0306**  

- ▶ Pencil sharpener, single hole, block design, injection-moulded blade



**0317**  

- ▶ Pencil sharpener, single hole, 'olive' design

## TOP DUO WITH BUILT-IN PLASTIC SHARPENER

The low-cost alternative to the classic TOP DUO comes in a contemporary mix of shifting colours.



**0344**  
**TOP DUO®**  

- ▶ Container sharpener for lead and coloured pencils, double hole, with coloured integrated plastic sharpener, closable

## TOP UNO AND TOP DUO IN NEW COLOURS

Our two top sellers with high-quality integrated metal sharpeners, in bright new colours.

**0351**  
**TOP UNO®**  

- ▶ Container pencil sharpener, single hole, with integrated metal sharpener, closable

**0355**  
**TOP DUO®**  

- ▶ Container sharpener for lead and coloured pencils, double hole, with integrated metal sharpener, closable



**0356**  
**LITTLE QUATTRO SWING®**  

- ▶ Container sharpener for lead and coloured pencils, double hole, with integrated metal sharpener, closable



**0311**  

- ▶ Sharpener for lead and coloured pencils, double hole, wedge design



**0324**  

- ▶ Pencil sharpener, single hole, round



**0338**  

- ▶ Pencil sharpener, single hole, block design, injection-moulded blade



**0907**  
**ELLIPTIC LINE®**  

- ▶ Container pencil sharpener, single hole, with integrated plastic sharpener



**0941**  
**RONDO SWING®**  

- ▶ Container sharpener for lead and coloured pencils, double hole, with integrated plastic sharpener, extra large shavings container



**0914**  

- ▶ Container pencil sharpener, single hole, clamped blade, with integrated plastic sharpener, screw-on lid



**0909**  
**EASY LIGHT**  

- ▶ Container pencil sharpener, single hole, with integrated plastic sharpener

# CONTAINER & MULTIFUNCTIONAL PENCIL SHARPENERS

The ideal solution for individual sharpening needs – Möbius+Ruppert provides container pencil sharpeners for the needs and preferences of all ages. For teenagers we offer one-hole and two-hole sharpeners as well as chic multifunction sharpeners with integral eraser. The “for Lefties” edition was developed especially for left-handers and includes a ruler with a reverse-running scale.



**0343**  
**MINI ELLIPTIC SWING®**



► Container pencil sharpener, single hole, with integrated metal sharpener



**0357**  
**Little ELLIPTIC SWING®**



► Container pencil sharpener, single hole, with integrated metal sharpener, automatically-closing opening, compact design



**0938 0330**  
**ELLIPTIC SWING®**



► Container sharpener for lead and coloured pencils, double hole, Soft Touch feel, with integrated metal sharpener, container with Look-Thru function



**0916**  
**ELLIPTIC SWING®**



► Container sharpener for lead and coloured pencils, double hole, with integrated metal sharpener and folding closure, extra large shavings container



**0938 0050**  
**ELLIPTIC SWING®**



► Container sharpener for lead and coloured pencils, double hole, with integrated metal sharpener, extra large shavings container



**0953**  
**TRIO SWING®**



► Container pencil sharpener, single hole, with integrated metal sharpener



**0923 0050**  
**QUATTRO SWING®**



► Container pencil sharpener, single hole, with integrated metal sharpener



**0924 0050**  
**QUATTRO SWING®**



► Container sharpener for lead and coloured pencils, double hole, with integrated metal sharpener

## SLENDER, WITH ERASER

A separate compartment keeps the integral eraser safe from lead dust – an easy way of ensuring clean, neat drawings.



**0945**  
**ELLIPSTICK SWING®**



► Container sharpener, single hole, with integrated metal sharpener and eraser, designed specially for school pencil cases



**0955**



► Container pencil sharpener, single hole, with integrated metal sharpener and eraser, sliding closure prevents shavings falling out, flat, compact shape



**0928**

**ELLIPTIC SWING®**



► Container sharpener for lead and coloured pencils, double hole, with integrated metal sharpener

**0929**

**ELLIPTIC SWING®**



► ELLIPTIC SWING® is also available as a single hole sharpener



**0938 0300**  
**ELLIPTIC SWING®**



► Container sharpener for lead and coloured pencils, double hole, Soft Touch feel, with integrated metal sharpener

**0919 0300**  
**ELLIPTIC SWING®**



► ELLIPTIC SWING® is also available as a single hole sharpener

## ESPECIALLY FOR LEFTIES

The proven QUATTRO SWING® series design with snap cap is now available in a special left-hander version.



**0924 0090**  
**QUATTRO SWING® for Lefties**



► Container sharpener for left-handers, for lead and coloured pencils, double hole, with integrated metal sharpener  
► You can find the ruler to go with it with reverse-running scale on page 14

for Lefties

# HIGH QUALITY DRAWING INSTRUMENTS FOR SCHOOL USE

Versatile, practical, precise: The Möbius+Ruppert line of drawing instruments for school & hobby includes rulers, geometric triangle protractors, set squares and templates in various designs and materials. A 4-piece set in a handy case meets basic school needs with just one purchase.



<b>1116 0000</b> (Image)	clear	16 cm
<b>1116 0080</b>	black	16 cm



<b>1116 0150</b>	coloured	16 cm
------------------	----------	-------



<b>1120 0000</b> (Image)	clear	20 cm
--------------------------	-------	-------



<b>1130 0080</b> (Image)	black	30 cm
<b>1130 0150</b>	coloured	30 cm



<b>1130 0000</b> (Image)	clear	30 cm
<b>1140 0000</b>	clear	40 cm
<b>1150 0000</b>	clear	50 cm

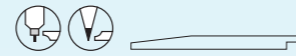

► Rulers for the use at school and office

**Material:** clear polystyrene

<b>2110</b>	Base 10 cm
-------------	------------

► Semi-circular protractor, two-way scale from 0° to 180°, centring point, mm graduation

**Material:** clear polystyrene



<b>2410</b> (Image)	ø 10 cm	<b>2415</b>	ø 15 cm
---------------------	---------	-------------	---------

► Full-circle protractor, two-way scale from 0° to 360°, in poly bag

**Material:** clear polystyrene

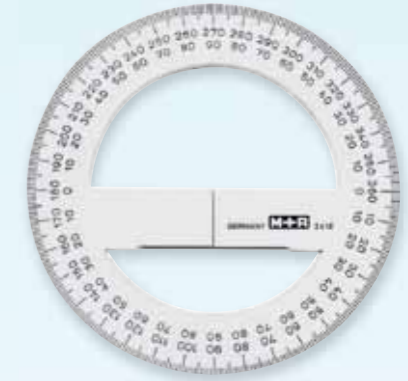

## SET: ALL YOU NEED FOR SCHOOL

Drawing instrument set, four pieces: well equipped for school.

<b>7030</b>	Drawing instruments set, 4 pieces, in plastic envelope, containing:		
-------------	---	--	--

► Drawing instruments set, 4 pieces, in plastic envelope, containing:

<b>1130</b>	ruler, 30 cm		
<b>2316</b>	geometric triangle protractor	16 cm	
<b>4520</b>	set square 45°	20 cm	12 cm
<b>6020</b>	set square 60°	23 cm	18 cm

**Material:** clear polystyrene

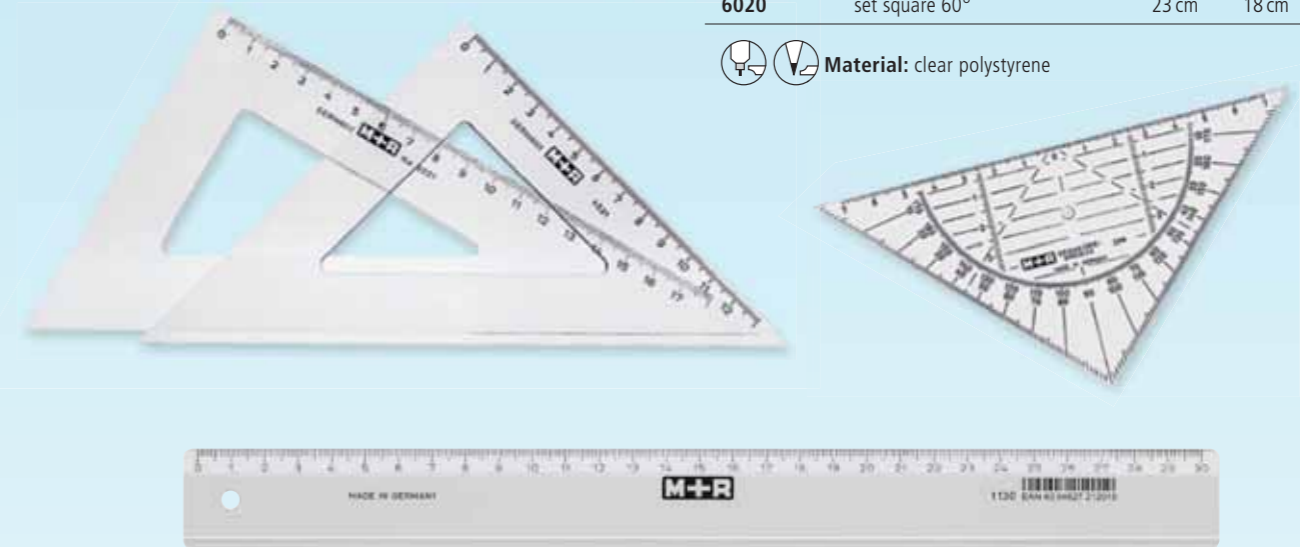

## RULER FOR LEFT-HANDERS

The "for Lefties" series ruler has a reverse-running scale from right to left for convenient left-hand use.



► Left-handed rulers, scale runs from right to left

► A perfect match for the left-handed sharpener on page 13

**Material:** clear polystyrene



<b>1116 0090</b>	16 cm	<b>1130 0090</b> (Image)	30 cm
------------------	-------	--------------------------	-------

for  
Lefties





# THOUGHT OUT DOWN TO THE DETAILS

Scarcely visible yet thought out to the smallest detail – the high quality of the drawing instruments made by Möbius+Ruppert is evident not just in their durable and precise markings, but also details like bevelled edges and inking edges.

**2316** Base 16 cm

► Geometric triangle protractor, two-way scale, in plastic envelope

**Material:** clear polystyrene

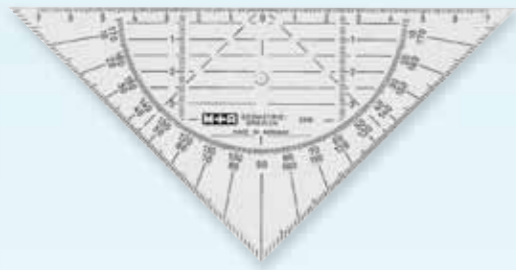

**2319** Base 16 cm

► Flexible geometric triangle protractor, two-way scale, white backed, in plastic envelope

**Material:** clear PETG (without PVC)

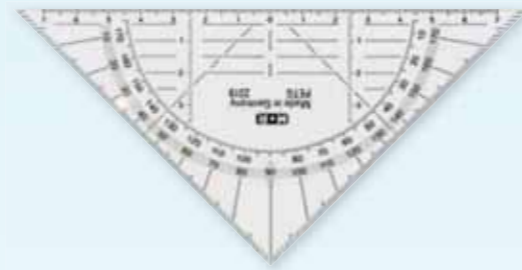

**2317** Base 16 cm

► Geometric triangle protractor, two-way scale, red backed, in plastic envelope or paper envelope

**Material:** clear polystyrene



**8507** 123 x 70 x 2 mm

► Parabola templates, standard parabola  $y = x^2$ , 2 sine-cosine curves, in plastic envelope

**Material:** clear acrylic

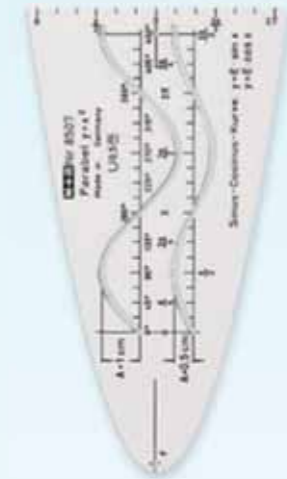

## GET A GRIP ON IT

The detachable handle speeds up work processes and provides extra security during use.

**2315** Base 16 cm

► Geometric triangle protractor with fixed handle, two-way scale, red backed, in plastic envelope

**Material:** clear polystyrene



**2318** Base 16 cm

► Geometric triangle protractor with detachable handle, two-way scale, colour backed, in plastic envelope

**Material:** clear acrylic or polystyrene



Image: acrylic



Image: polystyrene

**2317 0150** Base 16 cm

► Geometric triangle protractor, two-way scale, white backed, in plastic envelope

**Material:** coloured polystyrene ●●



**8509** 123 x 70 x 1.8 mm

► Parabola templates, standard parabola  $y = x^2$ , 2 sine-cosine curves and tangent, in plastic envelope

**Material:** clear polystyrene





## Office & Studio

Creating a blueprint for quality – that's one of the most important goals in the office and studio. True quality is reflected in the details, which is why every detail counts here. Give your customers the best possible tools, so that they can concentrate on what really matters.

## SHARPENERS THAT DELIVER QUALITY AND AESTHETICS

Whether elegant in brass or classic in magnesium, our open sharpeners for office and studio not only look good, they're also very practical and precise. Our professional product line ranges from single, double and triple hole versions to replacement blades.



0604



► Brass pencil sharpener, single hole, 'bullet' design



0602



► Brass sharpener for lead and coloured pencils, double hole



0603



► Brass sharpener for lead and coloured pencils, double hole, wedge design



0202



► Pencil sharpener, single hole, bed design



0205



► Pencil sharpener, single hole, rounded wedge design



0207



► Pencil sharpener with two additional special functions



0200



► Pencil sharpener, single hole, block design



0220



► Pencil sharpener, single hole, block design, with two replacement blades



0100

► replacement blades

### FOR LEAD AND COLOURED PENCILS

This combination ensures fine, compact tips, especially for coloured pencils and artists' pencils with delicate leads.



0212



► Sharpener for lead and coloured pencils, double hole, wedge design, for lead and coloured pencils of normal diameter



# CONTAINER SHARPENERS AND MORE FOR THE OFFICE

Our office sharpener line incorporates timeless classics, award-winning designs and innovative materials solutions. We also offer electric sharpeners, special sharpeners for mechanical pencil points, and a pen-shaped stamp moistener.



0931



- ▶ Container sharpener for lead and coloured pencils, double hole, with integrated metal sharpener, patterned glass jar, screw-on lid



0900



- ▶ Container pencil sharpener, single hole, with integrated metal sharpener, screw-on lid, nostalgic appearance



0938 0100

ELLIPTIC SWING®



- ▶ Container sharpener for lead and coloured pencils, double hole, with integrated metal sharpener, soft touch



0950 0150

iLIGHT



- ▶ Container pencil sharpener, single hole, with integrated metal sharpener, folding closure, flat, compact design



0984



- ▶ Crank-style sharpener for lead and coloured pencils, quality cutter, high quality, solid die-cast housing, long cone for lead pencils, short cone for coloured pencils, selectable by knurled screw, large shavings container, with table mount

Produced by premium partners in Asia



0981



- ▶ Crank-style sharpener for lead and coloured pencils, quality cutter, transparent shavings container, rubber claws to protect the pencils, auto-stop when the pencil is sufficiently sharpened, long cone for lead pencils, short cone for coloured pencils, with table mount

Produced by premium partners in Asia



0986



- ▶ Battery-operated sharpener for lead and coloured pencils, transparent shavings container, batteries not included, 2 x 1.5 V batteries required, small, compact sharpener

Produced by premium partners in Asia



0927

RONDO SWING®



- ▶ Container pencil sharpener, single hole, with integrated metal sharpener, classic office sharpener



0923 0000

QUATTRO SWING®



- ▶ Container pencil sharpener, single hole, with integrated metal sharpener, classic office sharpener

0924 0000

QUATTRO SWING®



- ▶ Container sharpener for lead and coloured pencils, double hole, with integrated metal sharpener



0915

QUATTRO DESIGN



- ▶ Container pencil sharpener, single hole, with integrated plastic sharpener, classic office sharpener



0950

iLIGHT



- ▶ Container pencil sharpener, single hole, with integrated metal sharpener, folding closure, flat, compact design

**DESIGN PLUS**

In 1986 Möbius+Ruppert received the Design Plus Award at the international Frankfurt Consumer Goods Fair for the development of this container pencil sharpener.



0996

- ▶ Practical moistener with large water container for moistening stamps, envelopes, coloured paper and other gummed materials

## LEAD POINTER



0314



- ▶ Mini lead pointer

0970



- ▶ Lead pointer with large dust container, 4 adapters for different pencil diameters, two tip settings
- ▶ Adjustable setting and the extremely long guide gives leads exactly the right shape, without breaking

# HIGH-QUALITY RULERS FOR THE HIGHEST PRECISION

The Möbius+Ruppert meets the demands of professional drawing instrument users with our accustomed variety and dependable quality, in designs incorporating up to 6 scales. Precision is our focus here, in materials, workmanship and scale markings.

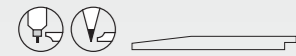

► Rulers for office and technical use, practical, wide profile, in poly bag or plastic envelope

**Material:** tinted polystyrene



<b>1020</b>	20 cm	<b>1040</b>	40 cm
<b>1030</b> (Image)	30 cm	<b>1050</b>	50 cm



► Metal rulers, cm and inch scales, in sleeve

**Material:** aluminium

Produced by premium partners in Asia



<b>1820</b>	20 cm / 8 inch	<b>1840</b>	40 cm / 16 inch
<b>1830</b> (Image)	30 cm / 12 inch	<b>1850</b>	50 cm / 20 inch



► Prism rulers, scales on both edges, full-length handle, in poly bag

**Material:** clear polystyrene



<b>1330</b>	30 cm	0-30 cm: ½ mm graduation 0-30 cm: mm graduation
-------------	-------	--



► Prism rulers, scales on both edges, full-length handle, in poly bag

**Material:** clear or white polystyrene



<b>1331</b>	30 cm	0-30 cm: ½ mm graduation 0-30 cm: mm graduation and 15-0-15 cm: mm graduation
-------------	-------	---

► Reduction scale rulers, six scales, available in four versions:



**1630 0000**

► Without coloured grooves, in sleeve

**Material:** white polystyrene

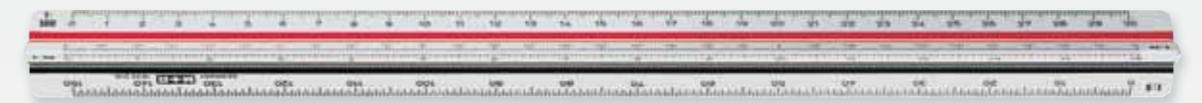

**1630 0010**

► Two coloured grooves, in hard plastic case

**Material:** white polystyrene

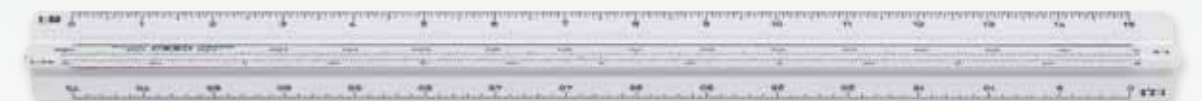

**1630 0090**

► Two coloured, short grooves, on blister card

**Material:** white polystyrene



**1631 0080**

► Reduction scale, two coloured grooves, in hard plastic case

**Material:** black polystyrene

► Divisions of the reduction scale rulers:

Model	Length	Scale	Divisions
<b>1630</b>	30 cm	Engineer	1:2.5    1:5
			1:10    1:30
			1:50    1:100
<b>1631</b>	30 cm	Architect 1	1:20    1:25
			1:50    1:75
			1:100    1:125
<b>1632</b>	30 cm	Architect 2	1:100    1:200
			1:250    1:300
			1:400    1:500
<b>1633</b>	30 cm	Parts to inch	1:10    1:20
			1:30    1:40
			1:50    1:60
<b>1634</b>	30 cm	Inches to foot	1:16    1:1+1/2
			1:1/4+1/8    1:1+1/2+3
			1:3/4+3/8    1:3/16+3/32
<b>1635</b>	30 cm	Vocational school	1:20    1:25
			1:33 <sup>1/3</sup> 1:50
			1:75    1:100
<b>1637</b>	30 cm	Surveyor 2	1:500    1:1000
			1:1250    1:1500
			1:2000    1:2500
<b>1638</b>	30 cm	ISO divisions	1:1    1:2
			1:5    1:10
			1:20    2:1

# GEOMETRY TRIANGLES, PROTRACTORS AND MORE

These versatile drawing instruments are designed for demanding office and studio tasks. Precision, long-lasting embossed markings, and details like tinted material or removable grips on the geometry triangles, give them high functionality.



<b>4516</b>	16 cm	10 cm	loose
<b>4520</b>	20 cm	12 cm	loose
<b>4525 (Image)</b>	25 cm	16 cm	in poly bag
<b>4532</b>	32 cm	19 cm	in poly bag

► set square 45°, mm graduation  
**Material:** clear polystyrene

## TINTED COLOUR OR BLACK

Our classic 45° set square is now available in elegant black, as well as the practical smoke-grey version.

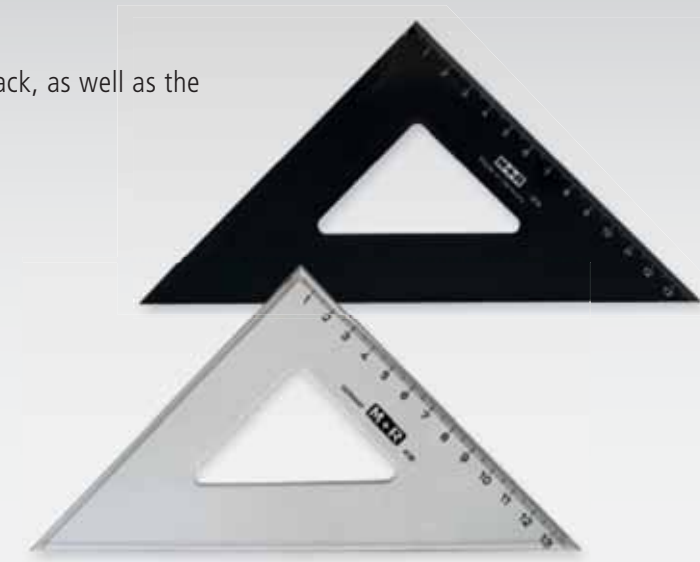

<b>4716 0080</b>	16 cm	11 cm	loose
<b>4720 0080 (Image)</b>	20 cm	13 cm	loose

► set square 45°, mm graduation, zero point at edge  
**Material:** black polystyrene

<b>4720 (Image)</b>	20 cm	13 cm	loose or in plastic envelope
<b>4725</b>	25 cm	16 cm	in poly bag or plastic envelope
<b>4732</b>	32 cm	21 cm	in poly bag or plastic envelope
<b>4736</b>	36 cm	23 cm	in poly bag or plastic envelope

► set square 45°, mm graduation, zero point at edge  
**Material:** tinted polystyrene

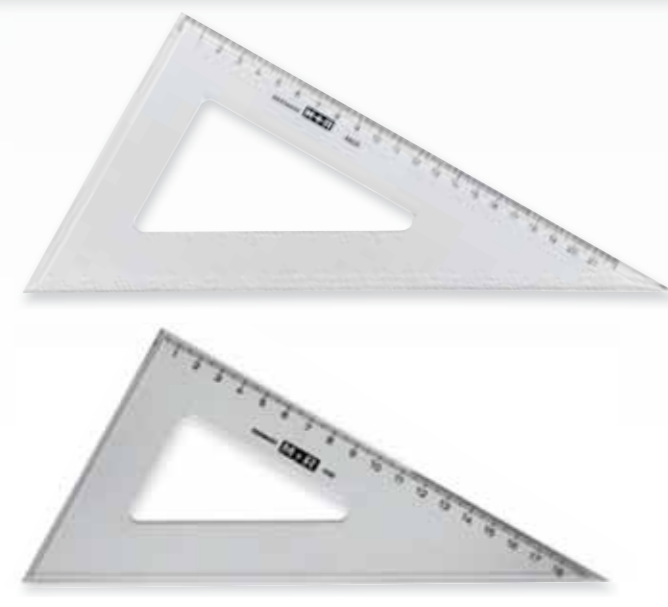

<b>6016</b>	18 cm	13 cm	loose
<b>6020</b>	23 cm	18 cm	loose
<b>6025 (Image)</b>	29 cm	22 cm	in poly bag
<b>6032</b>	37 cm	27 cm	in poly bag

► set square 60°, mm graduation  
**Material:** clear polystyrene

<b>6220 (Image)</b>	23 cm	18 cm	loose or in plastic envelope
<b>6225</b>	29 cm	22 cm	in poly bag or plastic envelope
<b>6232</b>	37 cm	27 cm	in poly bag or plastic envelope
<b>6236</b>	41 cm	33 cm	in poly bag or plastic envelope

► set square 60°, mm graduation, zero point at edge  
**Material:** tinted polystyrene

**Note:** The size of the set squares is measured at the hypotenuse for set squares 45°, and at the long leg for set squares 60°.



	<b>1530</b>	30 cm
--	-------------	-------

► ROLL ruler, with cut-out protractor, magnifier with 30 cm scale, several additional functions, in individual packing  
**Material:** clear acrylic

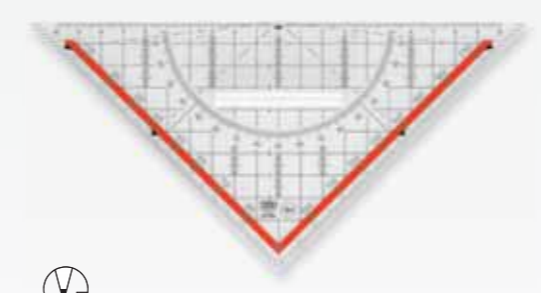

## COMFORTABLE USE, REMOVABLE GRIP

These technical drawing triangles are equipped with a removable grip, and come in two material versions.

Image: polystyrene

<b>2322</b>	Base 22 cm	<b>2322</b>	Base 32 cm
<b>2323</b>	Base 22 cm	<b>2325 (Image)</b>	Base 25 cm

► Geometric triangle protractors for technical drawing with fixed handle, two-way scale, colour backed, 180° to 1°, 45° line, 7°, 42°, 75° angles marked, hole for compass at zero point, mm graduation for drawing parallel lines, inking edges, in plastic envelope  
**Material:** clear acrylic

► Geometric triangle protractors for technical drawing, two-way scale, colour backed, 180° to 1°, 45° line, 7°, 42°, 75° angles marked, hole for compass at zero point, mm graduation for drawing parallel lines, inking edges, in plastic envelope  
**Material:** clear acrylic or polystyrene

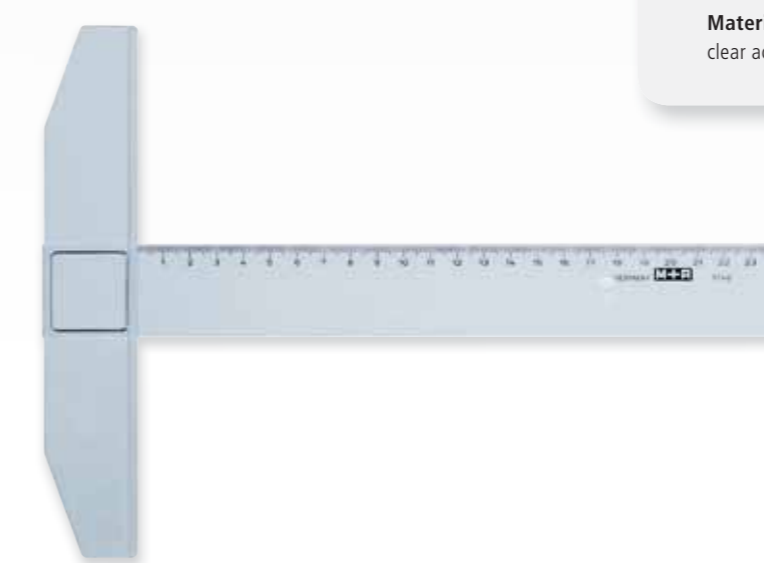

	<b>1740 (Image)</b>	40 cm
	<b>1760</b>	60 cm
	<b>1775</b>	75 cm

► T-squares, mm graduation, inking edges on both sides  
**Material:** transparent blue SAN (Styrene Acrylnitrile)

# PRECISION CAN'T BE COPIED

When the results depend on precision, you also need precision tools. Möbius+Ruppert templates have always met this need with their high quality in materials and workmanship.



**7083**

- French curve set, 3 parts, inking edges on both sides, in plastic envelope
- Sizes: 13 cm, 17 cm, 32 cm
- Material:** tinted polystyrene

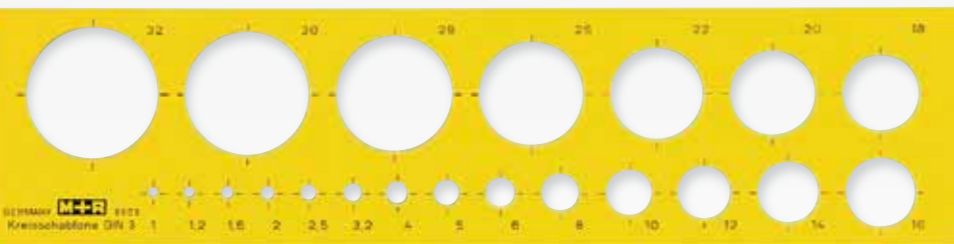

**8503**

248 x 60 x 1.5 mm

- Circle template, complies with German Industrial Standard DIN 3, circles 1.0 to 32 mm, 6 to 22 mm with 2 mm increases, in poly bag
- Material:** transparent yellow shock-resistant polystyrene

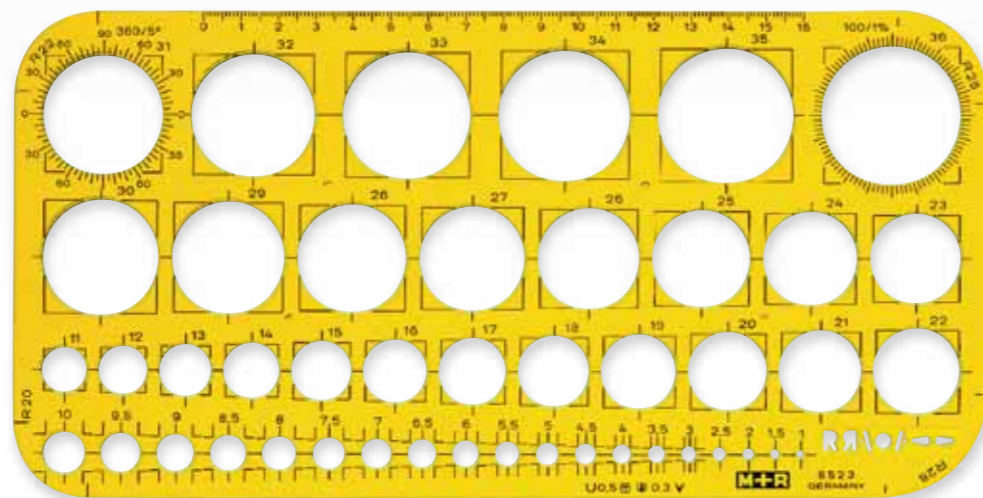

**8523**

260 x 130 x 2 mm

- Circle template, circles from 1 to 36 mm, up to 10 mm with 0.5 mm increases, scale from 0 to 16 cm in mm graduation, with 360°/5 and 100/1% graduation, 4 corner radii R20, R22, R25, R28, in plastic envelope
- Material:** transparent yellow shock-resistant polystyrene



<b>2061</b> (Image)	15 cm
<b>2062</b>	20 cm
<b>2063</b>	25 cm
<b>2064</b>	30 cm

- Adjustable angles from 90° to 1°, in individual packing
- Material:** clear acrylic



<b>9202</b> (Image)	ISO	Letter size 2.5 mm	<b>9205</b>	ISO	Letter size 5.0 mm
<b>9203</b>	ISO	Letter size 3.5 mm	<b>9207</b>	ISO	Letter size 7.0 mm

## SPOT ON

Standardized colour coding provides information about the tip length of suitable ink pens and fineliners.



- Lettering stencil for upright letters in compliance with ISO 3098.B, flexible, H profile, in plastic envelope
- Material:** transparent yellow polycarbonate



<b>8603</b>	Letter size 3.0 mm	<b>8606</b>	Letter size 6.0 mm
<b>8605</b> (Image)	Letter size 5.0 mm		



- Lettering stencil for bold, upright, medium-spaced lettering in compliance with German Industrial Standard DIN 1451, flexible, H profile, in plastic envelope
- Material:** transparent green polycarbonate

# CLEAN CUT – NEAT STACK

Our high quality paper trimmers ensure durable, accurate and consistently high-quality trimming, thanks to sophisticated technical details – and extremely stable, rigid cutting tables. These are made of aluminium in the premium segment, and of shock-resistant plastic in the lower-cost range.

## TRIM CAT® Guillotine trimmer

As a table-top model, this high quality guillotine trimmer can be used for every kind of application. It is especially useful for laminated film – but produces the desired results on all other kinds of material for cutting.

- ▶ Cutting blades in high-quality steel with laser-hardened cutting edge
- ▶ Lower knife of ground spring steel sharpens the lever blade with every stroke
- ▶ Distortion-free cutting table in aluminium or shock-resistant plastic with cm/inch scale markings and all customary formats

- ▶ Clamp for material to be cut and finger guard at cutting edge
- ▶ Cutting height up to max. 0.8 mm
- ▶ Cutting capacity: 8 sheets (80 g paper), 0.8 mm cardboard



6432 (Image)	Cutting length: 320 mm
6426	Cutting length: 260 mm

**Material:** Aluminium cutting table

## FOR YOUR SAFETY

TRIM CAT® guillotine trimmer for DIN A4 with folding security protection screen



6532	Cutting length: 320 mm
------	------------------------

**Material:** Shock-resistant polystyrene cutting table

- ▶ Fold out safety guard
- ▶ Adjustable, lockable paper centring device
- ▶ Ergonomically-shaped cutting blade handle

## ROLL CAT®

These table-top rotary trimmers have a very wide range of applications. They make light work of cutting laminated film and all other materials which can be cut.

- ▶ Self-sharpening high-precision circular blade in hardened steel
- ▶ Lower knife made of ground spring steel
- ▶ Safety cutting head
- ▶ Precision cutting thanks to sprung blade bearing
- ▶ Cutting possible in both directions

- ▶ Stable, smooth-running guide rail made of aluminium
- ▶ Distortion-free cutting table in aluminium or shock-resistant plastic with cm/inch scale markings and all customary formats
- ▶ Integrated paper clamp at the cutting edge to hold material to be cut in place

### ROLL CAT® Basic Line

6332	Cutting length: 320 mm
------	------------------------

**Material:** Shock-resistant polystyrene cutting table



### ROLL CAT® Premium Line

6832	Cutting length: 320 mm
------	------------------------

**Material:** Shock-resistant polystyrene cutting table, black or white

- ▶ Completely enclosed safety cutting head, easy to change
- ▶ Guide rail in extra-rigid aluminium
- ▶ Handle for easy transport and simplicity of handling
- ▶ Adjustable, lockable paper centring device

#### Accessories:

- ▶ Cutting mat plus Perforation cutting head **6823**
- ▶ Cutting mat plus Wave Cut cutting head **6813**



### ROLL CAT® Premium Line

6732 (Image)	Cutting length: 320 mm
6726	Cutting length: 260 mm
6746	Cutting length: 460 mm
6752	Cutting length: 520 mm

**Material:** Aluminium cutting table

- ▶ Guide rail in extra-rigid aluminium
- ▶ Completely enclosed safety cutting head, easy to change



#### Accessories for 6732:

- ▶ Cutting mat incl. base plus Perforation cutting head **6723**
- ▶ Cutting mat incl. base plus Wave Cut cutting head **6713**

#### Accessories for all cutting lengths:

- ▶ Cutting table extension with paper stops **6704**



## Green Office

**Good for the office, good for the planet** – at Möbius+Ruppert we are constantly researching and developing ways to combine the two. Our Green editions use wood, cornstarch and recycled materials in their production. Once again, we see that quality products of quality materials can be made in harmony with nature.

## ECOLOGICAL AND SUSTAINABLE

Möbius+Ruppert paid attention to ecological, sustainable production before it was fashionable. We've added to our product range with the ECO EDITION, which is made of inhouse recycled materials.



0400



► Beechwood sharpener, for lead pencils, single hole, untreated



0411



► Beechwood sharpener for lead and coloured pencils, double hole, untreated



### NATURALLY WOOD

Wood is a natural, self-renewing material. Our beechwood is untreated and sourced from European forests.



1917

17 cm



1920

20 cm



1930 (Image)

30 cm

1940

40 cm

1950

50 cm

► High quality wooden rulers, with metal insert, untreated

**Material:** beechwood



## GREEN LINE & ECO EDITION

Sharpeners made of organic and ecological materials, for the good of the environment. At Möbius+Ruppert we're moving ahead on sustainability and environmental protection in two ways. One is the use of renewable materials, such as the cornstarch we use to make our GREEN LINE Series products. The other is the use of production waste to make the QUATTRO SWING® ECO EDITION products.

### SHARPENERS AND RULERS OF CORNSTARCH

The GREEN LINE Series was developed with sustainability in mind. The rulers and the sharpeners housing are made of a tough yet biodegradable cornstarch-based material.



0990 0810

GREEN LINE Collection

- Combination of GREEN LINE sharpeners 0919 and 0938 and rulers 1130, with display (cardboard)



0919 0810

GREEN LINE ELLIPTIC SWING®



- The Green Line container pencil sharpener is also available as a single hole sharpener



0938 0810

GREEN LINE ELLIPTIC SWING®



- The Green Line container pencil sharpener, double hole, made of biologically degradable, recyclable material, with integrated metal sharpener



### RE-USING PRODUCTION WASTE



After extensive development and testing, we have been successful in repurposing the waste materials from our production processes to make our ECO EDITION, while adhering to our high quality standards. The M+R QUATTRO SWING® sharpener is now available in the ECO version. We naturally pass the raw material savings on to you. This environmental edition is distinguished by the unique marbled structure of each cap.



0924 0650

QUATTRO SWING® ECO



- Container sharpener for lead and coloured pencils, double hole, made of recycled polystyrene, with integrated metal sharpener



# RIGHT FOR THE JOB, IN THE RIGHT PRESENTATION

Depending on how you need them, you can get Möbius+Ruppert products individually packaged in blister packs or cases. We deliver container sharpeners in the practical box that also functions as a countertop display. We also offer displays to match special editions or individual motif editions.

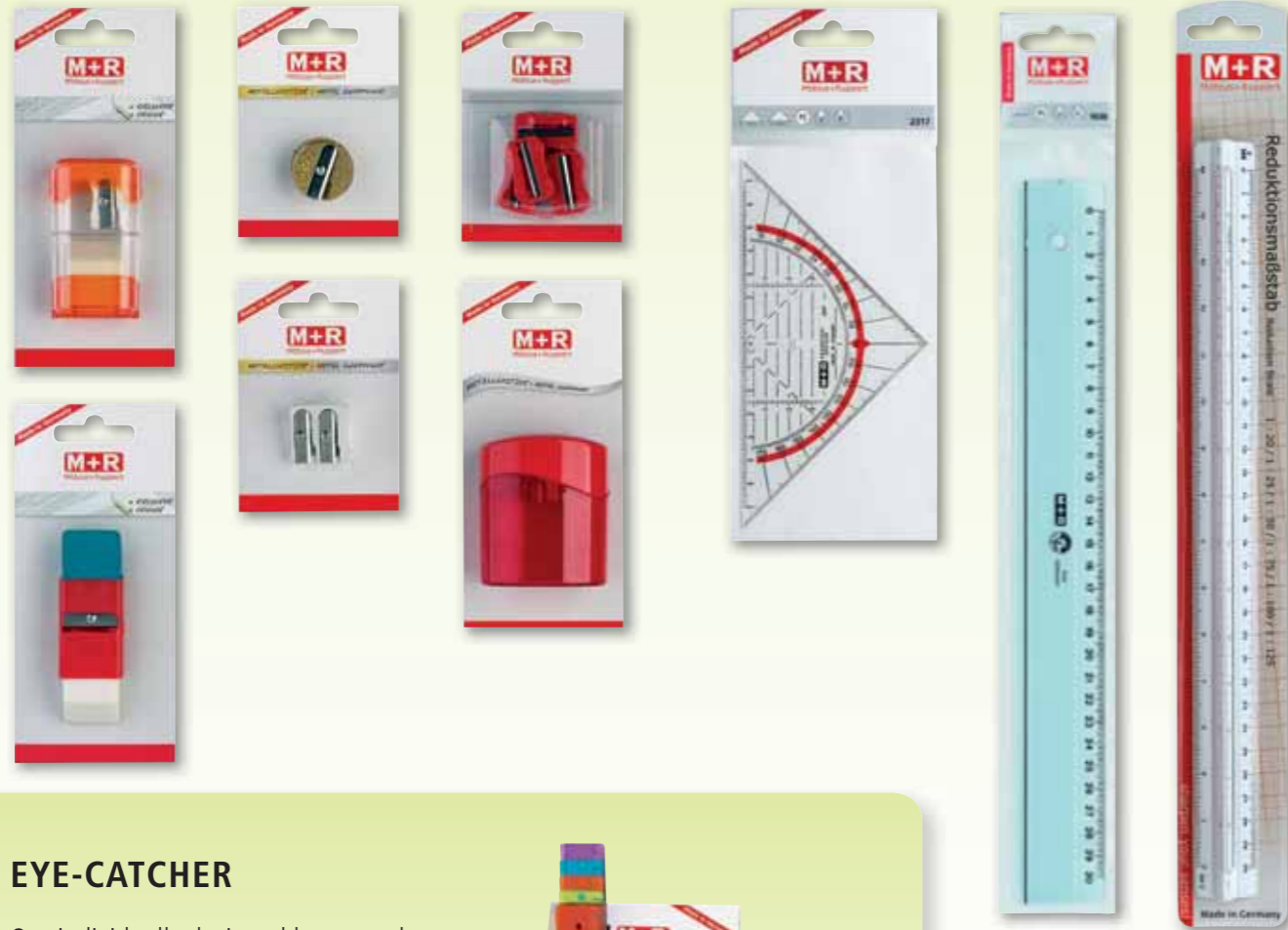

## EYE-CATCHER

Our individually designed boxes and displays are also suitable for counter-top presentation.



## ARTICLE NUMBERS AND PAGES

The following list contains all of the products we offer in ascending order. The first page number (black) refers to the catalogue page. The second (red) refers to the price list.

ART-NR.	CAT	PL
0100	19	3
0200	19	3
0200 0700	10	3
0201	10	3
0202	19	3
0205	19	3
0207	19	3
0211	10	3
0211 0700	10	3
0212	19	3
0220	19	3
0304	11	3
0305	11	3
0306	11	3
0311	11	3
0314	21	5
0316	7	3
0317	11	3
0324	11	4
0332	7	4
0333	7	4
0338	11	4
0342	6	4
0343	12	4
0344	10	4
0351	10	4
0355	10	4
0356	11	4
0357	12	4
0400	31	3
0411	31	3
0602	19	3
0603	19	3
0604	19	3
0900	20	4
0902	9	4
0907	11	4
0909	11	4
0914	11	4
0915	20	4
0916	12	4
0919 0810	32	4

ART-NR.	CAT	PL
0919 0300	13	4
0923 0000	20	4
0923 0050	13	4
0924 0000	20	5
0924 0050	13	5
0924 0090	13	5
0924 0650	33	5
0927	20	5
0928	12	5
0929	12	5
0931	20	5
0938 0050	13	5
0938 0100	20	5
0938 0300	13	5
0938 0330	12	5
0938 0810	32	5
0941	11	4
0945	12	5
0948	9	5
0950	20	5
0953	13	5
0955	12	5
0957	6	5
0958	6	5
0959	6	4
0969	5	4
0970	21	5
0981	21	6
0984	21	6
0986	21	6
0990 0810	32	6
0996	21	7
1020	22	7
1030	22	7
1040	22	7
1050	22	7
1116	14	7
1120	14	7
1130	14	7
1140	14	7
1150	14	7
1330	22	7

ART-NR.	CAT	PL
1331	22	7/8
1530	25	8
1630	23	8
1631	23	8
1632	23	8
1633	23	8
1634	23	8
1635	23	8
1637	23	8
1638	23	9
1740	25	9
1760	25	9
1775	25	9
1820	22	9
1830	22	9
1840	22	9
1850	22	9
1917	31	9
1920	31	9
1930	31	9
1940	31	9
1950	31	9
2061	27	9
2062	27	9
2063	27	9
2064	27	9
2110	15	9
2315	16	9
2316	16	9
2317	17	9/10
2318	16	10
2319	16	10
2322	25	10
2323	25	10
2325	25	10
2332	25	10
2410	15	10
2415	15	10
4516	24	10
4520	24	10
4525	24	10
4532	24	10

ART-NR.	CAT	PL
4716	24	10
4720	24	10
4725	24	10
4732	24	11
4736	24	11
6016	24	11
6020	24	11
6025	24	11
6032	24	11
6220	24	11
6225	24	11
6232	24	11
6236	24	11
6332	29	13
6426	28	13
6432	28	13
6532	28	13
6704	29	14
6713	29	14
6723	29	14
6726	29	13
6732	29	13
6746	29	13
6752	29	13
6813	29	14
6823	29	14
6832	29	13
7030	15	12
7083	26	12
8503	26	12
8507	17	12
8509	17	12
8523	26	12
8603	27	12
8605	27	12
8606	27	12
9202	27	12
9203	27	12
9205	27	12
9207	27	12

CAT = catalogue | PL = price list